

Amplifier-separated · Automatic Sensitivity Setting Photoelectric Amplifier
SU-7 Series

MJE-SU7 No.0034-27V

Thank you very much for purchasing Panasonic products.
Please read this Instruction Manual carefully and thoroughly for the correct and optimum use of this product.
Kindly keep this manual in a convenient place for quick reference.

WARNING

- Never use this product as a sensing device for personnel protection.
- In case of using sensing devices for personnel protection, use products which meet laws and standards, such as OSHA, ANSI or IEC etc., for personnel protection applicable in each region or country.

1 PART DESCRIPTION

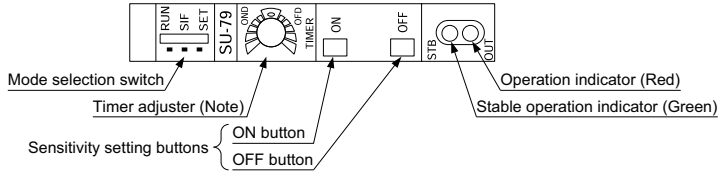

Note: It is the remote synchronization selection switch for **SU-75**.

2 MOUNTING

How to mount the amplifier

1. Fit the rear part of the mounting section of the amplifier on the attached amplifier mounting bracket (**MS-DIN-2**) or 35mm width DIN rail.
2. Press down the rear part of the mounting section of the unit on the amplifier mounting bracket or 35mm width DIN rail and fit the front part of the mounting section to the DIN rail.

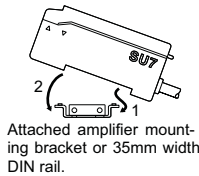

How to remove the amplifier

1. Push the amplifier forward.
2. Lift up the front part of the amplifier to remove it.

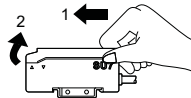

Note: Take care that if the front part is lifted without pushing the amplifier forward, the hook on the rear portion of the mounting section is likely to break.

3 HOW TO CONNECT THE SENSOR HEAD

How to use cable stripper (SU-CT1)

<Cutting cable>

1. Insert the cable into a hole provided for cutting in **SU-CT1**, and press the blade down.

Note: Do not stop the blade halfway. Press it up to the bottom in one stroke.

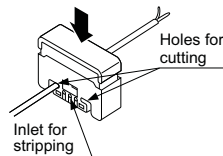

<Stripping cable>

1. Press the blade downwards and stop it at the middle of the stroke.

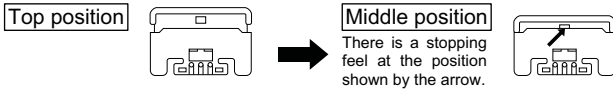

2. Insert the cable into one of the inlets provided for stripping at the center of **SU-CT1**.

Notes: 1) The cable must be inserted till it touches the stopper.

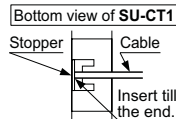

3. Press the blade fully down.

Notes: 2) Do not tilt the blade when pressing.



4. With the blade still pressed, rotate **SU-CT1** about a half-turn.

5. With the blade still pressed, withdraw **SU-CT1** from the cable. Only the insulation is stripped.

Notes: 3) Strip the cables one by one.

4) The blade of **SU-CT1** is not replaceable.

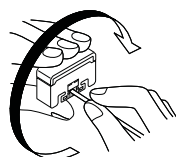

Sensor head connection

1. Open the case cover.
2. Process the cable end as shown on the right.

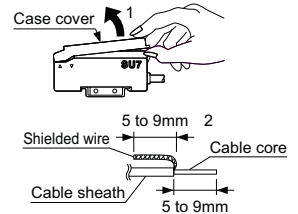

Notes: 1) Do not remove the cable core insulation.

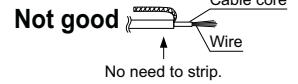

3. Bring down the cable lock lever.
4. Insert the cables into the cable inlets.
“▼” Receiver: Black cable
“▲” Emitter: Gray cable

Notes: 2) Both the shielded wires must be separately twisted and placed facing each other on the inside. Both inlets form symmetrical irregular ovals that include the supplementary holes facing each other. Insert the cables such that the shielded wires pass through the supplementary holes. If the shielded wires pass through a part other than the supplementary holes, misconnection will occur.

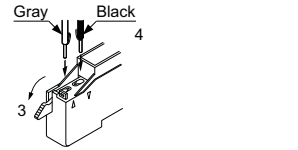

- 3) Place the shielded wires facing each other, and insert the cables straight, without bending, till the end.

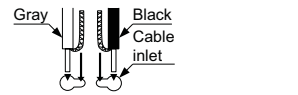

5. Pull up the cable lock lever to lock.

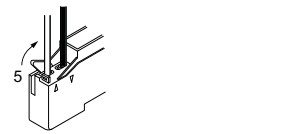

6. Put on the case cover.

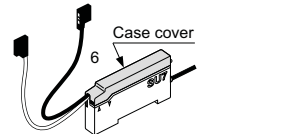

Notes: 4) If the cables are removed after releasing the lock lever, the same cables can be connected to the amplifier, once more, as they are. But for the third time, start from Step 2. If cable lock and release operation is repeated, the cable core may get cut causing a connection failure.

- 5) If the cable end is left in the insertion hole, insert the cable after removing the cable end left inside.

For removing the cable end, turn the sensor over and tap around the cable insertion holes. If this does not work, peel off the seal at the back of the amplifier and take out the cable end. (The seal can be stuck again.)

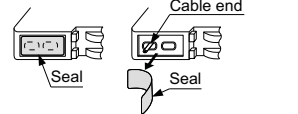

4 I/O CIRCUIT DIAGRAMS

<NPN output type>

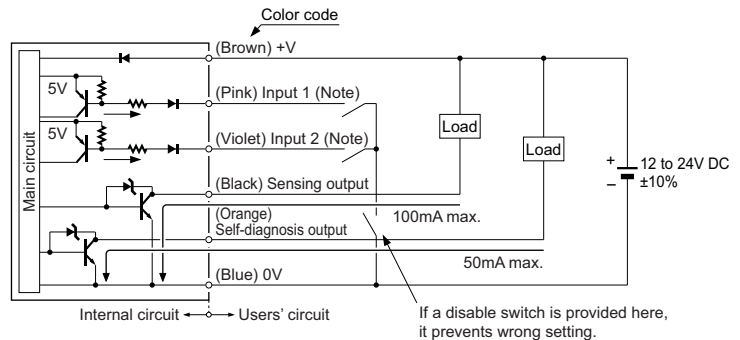

<PNP output type>

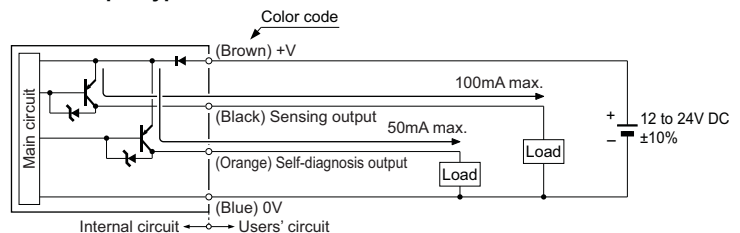

Note: The name of input wires differs depending on the model No.

Model No.	SU-7 SU-7P	SU-75	SU-77	SU-79
Input 1	—	External synchronization input (ES)	Remote sensitivity setting ON input (R. ON)	External sensitivity switching input 1 (S1)
Input 2	—	Test input (CONT.)	Remote sensitivity setting OFF input (R. OFF)	External sensitivity switching input 2 (S2)

5 SENSITIVITY SETTING

• Sensitivity setting

Normally, set the sensitivity as per [Standard Setting].

If the sensing is unstable, set as per limit, shift or full power setting.

Standard setting	<p>The operation level is set approximately halfway between the light intensity received for ON input and OFF input.</p>
Limit setting	The optimum sensitivity is set with one press of the button (or with one Low input). The sensitivity can be set without sensing an object.
Shift setting	If the received light intensity fluctuates either in the object present or absent state, shift the operation level towards the stable light intensity state.
Full power setting	The MAX. sensitivity is set. (Note)

Note: In case of reflective type sensor, if a background is present, the sensor may become ON even without an object.

[Standard Setting] (Automatic sensitivity setting function) <In case the sensing output is ON when object is detected.>

Setting procedures

Step	Operation
1	Place sensor head within the sensing range. (Note 1)
2	Set mode selection switch to "SET."
3	Press ON button with the sensing object present. (Release it within 3s.)
4	When ON state is recognized by the sensor, stable operation indicator (green) will blink.
5	Press OFF button with the sensing object absent. (Release it within 3s.)
6	<ul style="list-style-type: none"> The stable operation indicator will blink twice if the sensitivity difference (received light intensity difference) between ON state and OFF state is sufficient and a stable detection is possible. Stable operation indicator will blink continuously if stable detection is not possible. (Note 2) (Although the sensitivity is set, the sensitivity difference is not sufficient.)
7	Set mode selection switch to "RUN." Now, the sensitivity setting buttons are ineffective. So, even if the buttons are pressed by mistake, the registered sensitivity will remain unchanged.

<In case the sensing output is ON when object is not detected.>

In the above procedure

Press ON button with the sensing object absent.

Press OFF button with the sensing object present.

Notes: 1) As the sensing range will differ according to the type of sensor head, refer to the catalog. The sensing range for the reflective type sensor head is the figure for white non-glossy paper. The actual sensing range will differ according to the sensing object's color, surface condition, etc.

2) The sensitivity can be registered in the sensor even if the sensing condition is not stable.

• Setting by remote sensitivity setting input (For SU-77 only)

- Instead of pressing buttons, the sensitivity can be set with the remote sensitivity setting input.

(Shift setting cannot be done with remote sensitivity setting input.)

Setting procedure

- The procedure is the same as for setting with the sensitivity setting buttons, except that instead of pressing the buttons, the remote sensitivity setting input wire is short-circuited to 0V (Low). The mode selection switch is set to either the "SET" or "RUN" side.

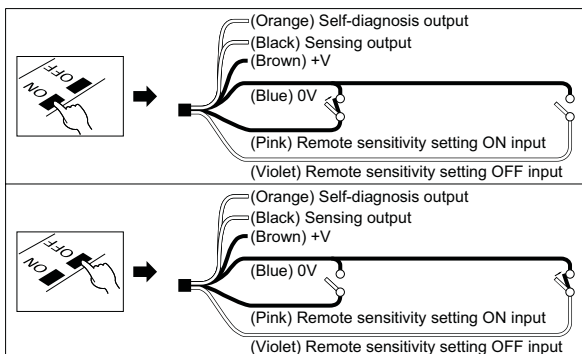

• Time chart

The self-diagnosis output stays ON for approx. 40ms after ON input or OFF input is recognized by the sensor.

[If the difference between the ON and OFF levels (the difference between incident light levels) is so small that stable detection is not possible, it does not turn ON.]

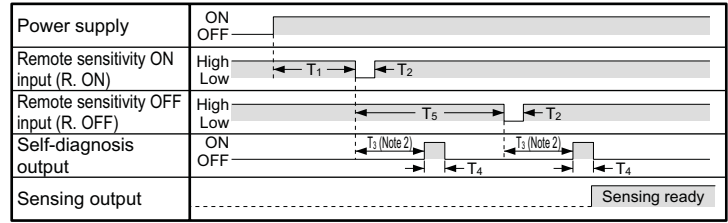

$T1 \geq 1,000\text{ms}$, $3,000\text{ms} > T2 \geq 5\text{ms}$, $T3 \approx 310\text{ms}$, $T4 \approx 40\text{ms}$, $T5 \geq 500\text{ms}$

Notes: 1) Signal condition ... Low: 0 to 1V, High: 4.5 to 30V or open, Input impedance: 10kΩ
2) Do not move the object, etc., or change the received light intensity during T3.

[Limit Setting] (Limit setting function)

For detecting a tiny object

For stable detection of an object without detecting the background

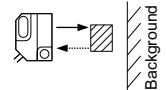
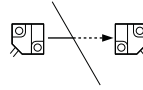

Setting procedures

Step	Operation
1	Set the sensor without an object and under stable light receiving condition.
2	Set mode selection switch to "SET."
3	By pressing either ON or OFF button for 3 sec. or more, the threshold level is set 15% either lower or higher than the object absent level as shown in the right figure. (Please note that the output operation cannot be reversed.) For example, press ON button for detecting a tiny object.
4	Set mode selection switch to "RUN."

• Time chart

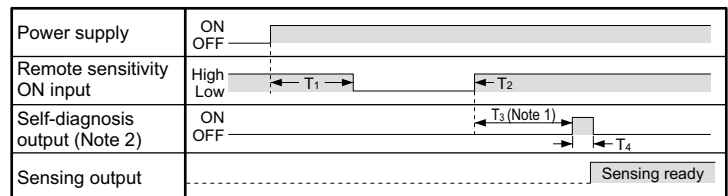

$T1 \geq 1,000\text{ms}$, $T2 \geq 3,000\text{ms}$, $T3 \approx 310\text{ms}$, $T4 \approx 40\text{ms}$

Notes: 1) Do not move the object, etc., or change the incident light intensity during T3.
2) Setting cannot be done if the light received is too strong or too weak.

[Shift Setting] (Sensitivity shift function)

- In case of using thru-beam type sensor heads in a dusty environment

The optical beam can be interrupted without a sensing object if there is dirt or dust on the sensor heads. Sensing will be more reliable against dirt or dust if the sensitivity is shifted towards the stable (sensing object sensed) side.

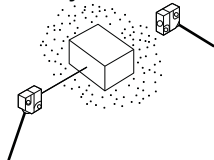

Setting procedures

Step	Operation
1	Set the sensitivity by following the standard setting procedure. (If the sensitivity margin is small, sensitivity shift cannot be done.)
2	Set mode selection switch to "SIF."
3	Press the sensitivity setting button which was pressed in the stable light received condition. For example, for a thru-beam type sensor, if there is dirt or dust, press the button which was pressed with the sensing object being sensed.
4	Set mode selection switch to "RUN."

[Full Power Setting]

Setting procedures

Step	Operation
1	Make sure that the sensor receives no light.
2	Set mode selection switch to "SET."
3	Press the "ON" button in the Light-ON mode. Press the "OFF" button in the Dark-ON mode.
4	When the input is recognized by the sensor, the stability indicator (green) blinks.
5	Press the "OFF" button in the Light-ON mode. Press the "ON" button in the Dark-ON mode.
6	When the input is recognized by the sensor, the stability indicator (green) blinks.
7	Set mode selection switch to "RUN."

6 EXTERNAL SENSITIVITY SWITCHING FUNCTION (For SU-79 only)

- Four different sensitivities can be registered in SU-79 and can be switched from one to another simply by external signals.

<Wiring diagram>

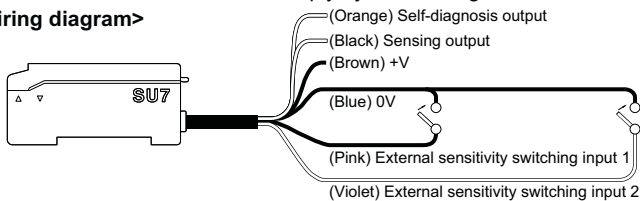

<Signal condition>

High	4.5 to 30V or open
Low	0 to 1V

<Channel selection>

No.	Input	External sensitivity switching input 1	External sensitivity switching input 2
1	Low	Low	Low
2	Low	Low	High
3	High	High	Low
4	High	High	High

<Sensitivity setting procedures>

- Set mode selection switch to "SET."
- Select the channel number by setting the external sensitivity switching input 1 or 2 to High or Low.
- Adjust the sensitivity by referring to the section "5 SENSITIVITY SETTING."
- Repeat steps 2 and 3 as required.
- Set mode selection switch to "RUN."

<Sensitivity switching procedures>

- Set mode selection switch to "RUN."
- Select the channel number by setting the external sensitivity switching input 1 or 2 to High or Low.

Notes: 1) It will take 310ms for the sensor to be able to sense after selecting the channel.
2) The timer duration is common for all channels.

7 EXTERNAL SYNCHRONIZATION FUNCTION (For SU-75 only)

- By using the external synchronization function, the timing for sensing can be controlled.

Trigger synchronization and gate synchronization are available.

• Time chart

	Trigger synchronization	Gate synchronization
Sensor signal	ON OFF	ON OFF
External synchronization input	High Low	High Low
Sensing output	ON OFF Approx. 40ms	ON OFF
External synchronization selection switch		

T ≥ 0.6ms (When using interference prevention function: T ≥ 0.8ms)

- Notes: 1) The external synchronization selection switch must be turned fully clockwise or counterclockwise.
2) When the external synchronization function is not used, set the external synchronization selection switch to gate synchronization and keep the external synchronization input open (High).



8 TEST INPUT (EMISSION HALT) FUNCTION (For SU-75 only)

- Emission is stopped when test input (emission halt input) (violet) is short-circuited to 0V (Low). Sensing output can be turned ON and OFF without a sensing object and this can be used for start-up inspection.

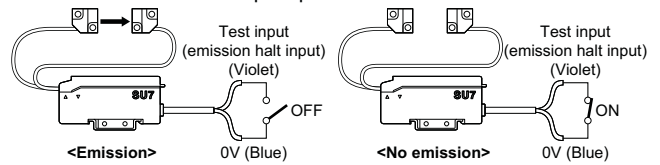

It is judged that sensor operation is normal if the sensing output follows the connection / disconnection of the test input, and abnormal if it does not follow.

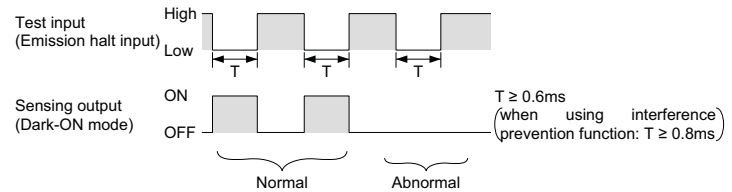

9 TIMER FUNCTION (Except for SU-75)

- SU-7, SU-77, SU-79, SU-7P are incorporated with 0 to 5s variable timer. Adjust the time duration of ON or OFF delay by turning the timer adjuster.

ON-delay timer (OND)

Function : Neglects short output signals.

Application: As only longer signals are extracted, this function is useful for detecting if a line is clogged, or for sensing only objects taking a long time to travel.

(e.g.) Sensing of jamming in an assembly line

OFF-delay timer (OFD)

Function : Extends the output signal for a fixed period of time.

Application: This function is useful if the output signal is so short that the connected device cannot respond.

• Time chart

Adjuster	Operation	Sensing condition	Sensing Non-sensing
	Normal	ON in sensing state	ON
		ON in non-sensing state	OFF
	ON-delay timer	ON in sensing state	OFF
		ON in non-sensing state	ON
	OFF-delay timer	ON in sensing state	OFF
		ON in non-sensing state	ON

Time: T = 0 to 5s

Notes: 1) Set the time period by setting the mode selection switch to "SET."

2) The first graduation is 40ms. From the second graduation onwards the time period increases and is 5s max.

10 SELF-DIAGNOSIS FUNCTION (All models)

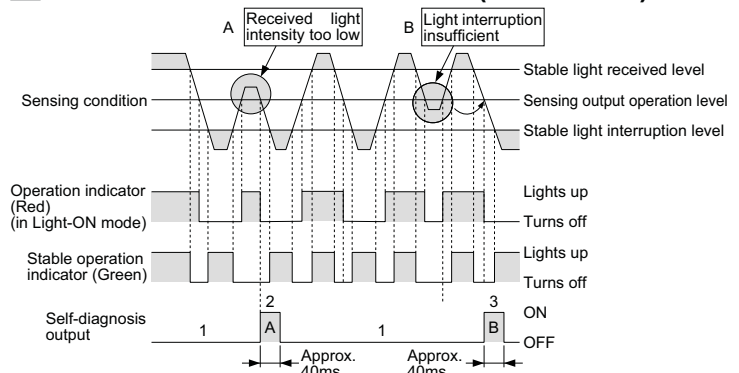

- The self-diagnosis output transistor is "OFF" during stable sensing.
- If the sensor does not reach either stable light received level or stable light interruption level when sensing output turns ON or OFF, self-diagnosis output once turns ON but turns OFF after approx. 40ms. (It does not affect the operation of the sensing output.)
- There is a delay for the self-diagnosis output to turn ON only when light interruption is insufficient.

11 STABILITY MARGIN INDICATING FUNCTION (All models)

- After setting the sensitivity, the margin of the set value can be visually confirmed. The stability margin can be confirmed by the number of times that the stable operation indicator (green) flashes when mode selection switch is slid to "SIF" or "RUN" from "SET."

No. of flashes	0	1	2	3	4	5
Relation with stable operation indicator						
Margin	Low		High			

Normally, the margin should be set as large as possible.
 (How to increase the margin: Shorten the sensing range, use an optimum sensor head, etc.)

12 INTERFERENCE PREVENTION FUNCTION (All models)

- The **SU-7** series has a built-in interference prevention function. Two sensor heads can be mounted very closely by setting different emission frequencies.

Setting procedures

Step	Operation
1	Set mode selection switch to "SET."
2	Press "ON" and "OFF" buttons simultaneously for minimum two seconds. As stable operation indicator (green) continues to blink, release the buttons.
3	Press "ON" button, and then release it. (Stable operation indicator will blink twice.)
4	Set mode selection switch to "RUN." (This completes the setting for one sensor.)
5	Apply Step 1 and 2 for the other sensor.
6	Press "OFF" button, and then release it. (The stable operation indicator will blink twice.)
7	Set mode selection switch to "RUN." (This completes the setting.)

Cancellation

Step	Operation
1	Press "ON" and "OFF" buttons simultaneously for minimum two seconds. Stable operation indicator (green) will blink. Release the button.
2	Press "ON" and "OFF" buttons simultaneously again. (Stable operation indicator will blink twice.)

- Notes: 1) When using interference prevention function, the hysteresis will increase, and the response time will be extended, as compared to normal operation. Always confirm the operation after setting the interference prevention function.
- 2) When the interference prevention function is used with thru-beam type sensors, set the sensitivity by standard setting, limit setting or shift setting.

Button	Emission frequency	Response time
ON	BROWN, +V BLACK, .OUT BLUE, .0V ORANGE, ALM PINK, .RON VIOLET, R.OFF FREQ.1 ■ FREQ.2 □	0.6ms or less
OFF	BROWN, +V BLACK, .OUT BLUE, .0V ORANGE, ALM PINK, .RON VIOLET, R.OFF FREQ.1 □ FREQ.2 ■	0.8ms or less

A mark can be put on the nameplate at the side of the sensor body. Please use this, if necessary.

13 CAUTIONS

- This product has been developed / produced for industrial use only.
- Make sure that the power supply is off while wiring and cascading.
- Do not run the wires together with high-voltage lines or power lines or put them in the same raceway. This can cause malfunction due to induction.
- Verify that the supply voltage variation is within the rating.
- If power is supplied from a commercial switching regulator, ensure that the frame ground (F.G.) terminal of the power supply is connected to an actual ground.
- In case noise generating equipment (switching regulator, inverter motor, etc.) is used in the vicinity of this product, connect the frame ground (F.G.) terminal of the equipment to an actual ground.
- Do not use during the initial transient time (0.5 sec.) after the power supply is switched on.
- Extension up to total 100m is possible with 0.3mm², or more, cable. However, in order to reduce noise, make the wiring as short as possible.
- The self-diagnosis output does not incorporate a short-circuit protection circuit. Do not connect it directly to a power supply or a capacitive load.
- Make sure that stress by forcible bend or pulling is not applied to the sensor cable joint.
- This product is suitable for indoor use only.
- Avoid dust, dirt, and steam.
- Take care that the product does not come in contact with oil, grease, or organic solvents, such as thinner, etc., strong acid or alkaline.

14 SPECIFICATIONS

Item	Model No.	NPN output				PNP output
		Standard type	External synchronization input type	Remote sensitivity setting type	Remote sensitivity selection type	Standard type
Applicable sensor head		SU-7	SU-75	SU-77	SU-79	SU-7P
Supply voltage		12 to 24V DC±10% Ripple P-P 10% or less				
Current consumption		35mA or less				
Sensing output		<NPN output type> NPN open-collector transistor • Maximum sink current: 100mA • Applied voltage: 30V DC or less (between sensing output and 0V) • Residual voltage: 1.0V or less (at 100mA sink current) 0.4V or less (at 16mA sink current)		<PNP output type> PNP open-collector transistor • Maximum source current: 100mA • Applied voltage: 30V DC or less (between sensing output and +V) • Residual voltage: 2.0V or less (at 100mA source current) 1.0V or less (at 16mA source current)		
	Output operation	ON / OFF mode is set by the ON / OFF buttons. (Note 2)				
Short-circuit protection		Incorporated				
Self-diagnosis output		<NPN output type> NPN open-collector transistor • Maximum sink current: 50mA • Applied voltage: 30V DC or less (between self-diagnosis output and 0V) • Residual voltage: 1.0V or less (at 50mA sink current) 0.4V or less (at 16mA sink current)		<PNP output type> PNP open-collector transistor • Maximum source current: 50mA • Applied voltage: 30V DC or less (between self-diagnosis output and +V) • Residual voltage: 2.0V or less (at 50mA source current) 1.0V or less (at 16mA source current)		
	Output operation	ON in unstable sensing condition (restored after approx. 40ms) or when sensing output is short-circuited (restored when short-circuit is removed) (For SU-77 , it turns ON for approx. 40ms also after the remote sensitivity setting input is received.)				
Short-circuit protection		—				
External input		—	Signal condition High ... 4.5 to 30V or open Low ... 0 to 1V Input impedance: 10kΩ	—		
Response time		0.6ms or less (0.8ms or less when interference prevention function is used)				
Ambient temperature		-10 to +55°C (No dew condensation or icing allowed) Storage: -20 to +70°C				
Ambient humidity		35 to 85% RH, Storage: 35 to 85% RH				
Material		Enclosure: Heat-resistant ABS, Enclosure: Polycarbonate Cable lock lever: PPS				
Weight		Approx. 65g				
Accessory		MS-DIN-2 (Amplifier mounting bracket): 1 pc. SU-CT1 (Stripper): 1 pc.				

- Notes: 1) The plug-in connector type of **SU-7** has suffix "J" at the end of the model No. Model No.: **SU-7J**
 Except for the connector portion, its specifications are the same as for **SU-7**.
- 2) For **SU-77**, it can also be set by the remote sensitivity setting input.

15 USE CONDITIONS TO COMPLY WITH CE MARKING

- Intended products for CE Marking
- Amplifiers **SU-7(P), SU-75, SU-77, SU-79**
- Applicable sensor heads **SH-31R, SH-31G, SH-33R, SH-32R**

- Note1: Contact our office regarding other than above models.
 Note2: Contact for CE
 <Until June 30, 2013>
 Panasonic Electric Works Europe AG
 Rudolf-Diesel-Ring 2, D-83607 Holzkirchen, Germany
 <From July 1, 2013>
 Panasonic Marketing Europe GmbH Panasonic Testing Center
 Winsbergring 15, 22525 Hamburg, Germany

- Following work must be done in case of using this product as a CE marking conforming product.

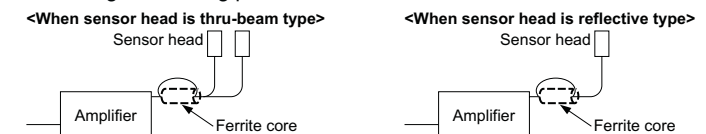

- Place a ferrite core near the amplifier.
 In that condition, the sensor head cable should be single-winding.
 Prepare 1 pc. of the following recommended ferrite core (or an equivalent product.)
 <Recommended product>
 ESD-SR-110 [NEC TOKIN Co., LTD.]

Panasonic Industrial Devices SUNX Co., Ltd.

<http://panasonic.net/id/pidsx/global>

Overseas Sales Division (Head Office)
 2431-1 Ushiyama-cho, Kasugai-shi, Aichi, 486-0901, Japan
 Phone: +81-568-33-7861 FAX: +81-568-33-8591

About our sale network, please visit our website.

PRINTED IN JAPAN

© Panasonic Industrial Devices SUNX Co., Ltd. 2012